

MACK[®]

More efficiency. More performance.



MACK ANTHEM[®]

The ultimate combination of efficiency, comfort and connectivity, Mack Anthem is the prime mover that goes the distance for your business. With superior horsepower, torque and fuel economy, Anthem delivers more performance than ever before.

Max GVWR

27.6
TONNE

Power

535
MAX HP

Peak Torque

2,065
LBS.-FT. MAX

ANTHEM

Key Features

Perfect for open highway, local and interstate distribution, heavy construction, tipper and dog configurations

Powered by the Mack MP⁸ engine delivering up to 535hp and 1,920lb.ft. (2,600Nm) torque

mDRIVE[™] automated manual transmission with deep reduction gears, takes all the effort out of gear changes and provides flexibility in low speed applications

Mack PowerLeash offers ultimate engine braking control under demanding conditions

“Road Stability Advantage” rollover prevention

Great fuel economy and low emissions

Mack Infotainment system with Apple CarPlay, Android Auto compatibility and wireless phone charging pocket

Quiet and comfortable cab

Built in Australia for Australian conditions



Comfortable Interiors

The Mack Anthem comes with new levels of driver comfort and functionality, to keep drivers comfortable and safe all day. Tilt/telescoping steering column, air suspension driver seat and all controls within reach keep drivers in control.

Total Support

Mack Genuine Parts are as tough as your truck. With premium materials and precision engineering, they're built to take whatever the road can throw at them. Mack Total Support gives you the added confidence of warranties, servicing and maintenance from the people who made your machine. With Australia's largest dealer network, you can take advantage of the peace of mind that comes with a Mack service plan tailored to your business.

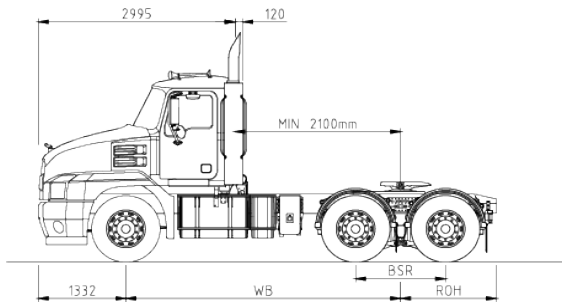

6x4 Day Cab Tractor

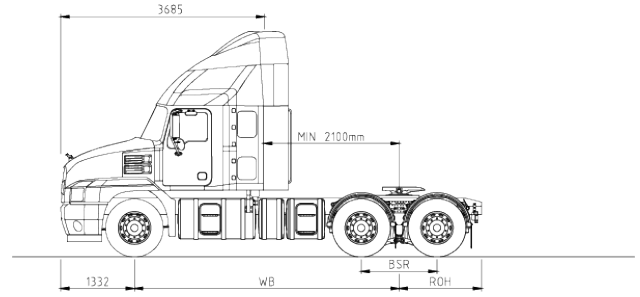

6x4 36-Inch Stand Up Sleeper (914mm)

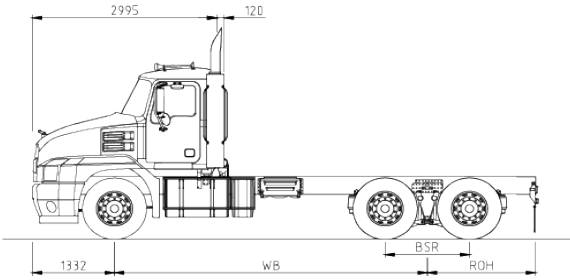

6x4 Day Cab Rigid

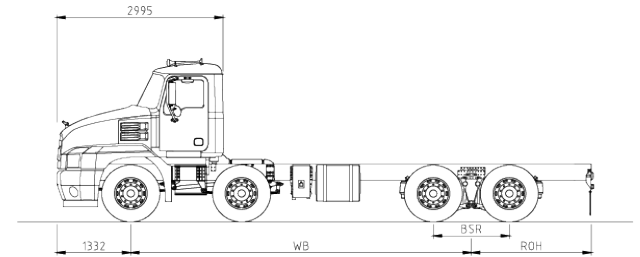

8x4 Day Cab

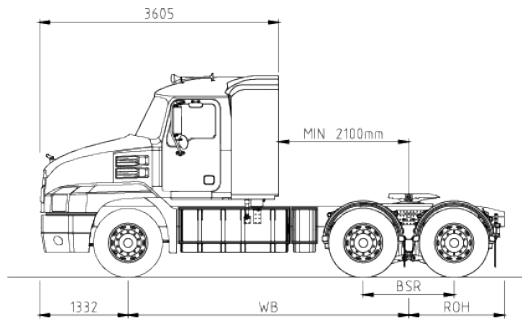

6x4 28-Inch Super Cab (710mm)

Configuration*	6x4		8x4		
GCM	Please speak with your Mack Dealer for GCM ratings specific to your chosen spec.				
Cab Type	Day Cab Tractor	Day Cab Rigid	28" Super Cab	36" Sleeper	Day Cab
Wheelbase (mm.)	4,410, 4,460, 4,485, 4,710, 4,735, 4,910, 4,935, 5085	5,085	4,710 4,735	4,785 4,860 4,885	5,410, 5,435, 5,710, 5,735, 6,110, 6135
Maximum Fuel Capacity** L	850	935	1,005	1,450	600
AdBlue Tank Capacity** L	95 125	125	125	150	60

*Other configuration options available via C.A.

**Various fuel packages available.

ENGINE	Mack MP8 13 litre, 435hp, 500hp, 535hp eSCR Emission Level Euro6 (ADR80-04)		
HP/Torque	435hp (330kW) / 1,655lb.ft (2,240Nm)		
	500hp (373kW) / 1,840lb.ft. (2,500Nm) & 500hp (373kW) / 2065lb.ft (2800Nm), MP8HE only		
	535hp (399kW) / 1,920lb.ft (2,600Nm)		
Engine Brake	Advanced PowerLeash engine brake Engine retarding power up to 495hp (370kW)		
Exhaust	Single RHS frame mounted catalyst with stain- less steel heat shield		
	Outlet twin 152mm (6") vertical exhaust		
	Exhaust tip height above ground 3.5m		
	RHS low underframe exhaust outlet		
Air Intake & Filter	Donaldson 279mm (11") single dry type		
	Steel dust extractors and external raised air intakes mounted in front of the cabin 'A' pillars		
TRANSMISSION	STANDARD	OPTION	OPTION
Transmission Type	AMT <i>m</i> DRIVE 12-speed	AMT <i>m</i> DRIVE HD 13-speed	AMT <i>m</i> DRIVE XHD 14-speed
Multispeed Reverse Gears	4	6	6
LO / HI	14.94 / 1.00	17.54 / 1.00	32.04 / 1.00
FRONT AXLE	Mack FXL 14.6 Single Steer		Mack FXL 14.6 Twin Steer
Capacity	14,600 lbs (6.6t)		29,200 lbs (13t)
Suspension	Front Multileaf Spring Front Parabolic Spring		
CHASSIS FRAME	OPTION	STANDARD	OPTION
Rail Dimensions	300 x 90 x 7mm	300 x 90 x 8mm	300 x 90 x 9.5mm

■ Shaded areas indicate optional specifications.

REAR AXLE	STANDARD	OPTION	OPTION
Axle Type	Meritor RT46-160GP	Meritor MT40-14XGP	Mack 2370B
Capacity	46,000 lbs (21t)	40,000 lbs (18t)	50,000 lbs (23t)
Suspension	Mack AL460 Air Suspension		
	Mack AP460 Air Suspension		
	Mack Air Ride Suspension		
	Maxlite Air Suspension		
	Rear Leaf Suspension B-Ride		
CAB	Fusion Cab, ECE29 (cab strength test) compliant		
Cab Storage	Overhead storage available		
	Rear Wall storage available		
	Door Storage (2 pockets)		
	Centre storage console available		
Cab Type	Day Cab		
	Super Cab - 710mm Rear Cabin Extension (28")		
	Sleeper - 914mm Stand-Up Mid-Rise (36")		
BRAKE SYSTEM	Bendix Antilock Braking System		
Front Brakes	Front 'S' Cam with Iron Brake Drum		
	Front Disc Brake		
Rear Brakes	Rear 'S' Cam with Iron Brake Drum		
	Rear Disc Brake		
	ABS		
	Grade Gripper - Hill Start Assist		
	Mack Road Stability Advantage (ESP - Electronic Stability Program)		

SAFETY	Advanced active safety technology
Alerts	Alert Prioritisation
	Bendix Blindspotter
	Following Distance Alert
	Impact Alert
	Lane Departure Warning
	Stationary Object Alert
Braking Intervention	Stationary Vehicle Braking
	Enhanced Collision Mitigation
	Adaptive Cruise Control With Braking
	Multi-Lane Automated Emergency Braking
	Highway Departure Braking
FUEL TANKS	Various fuel packaging options available
LHS	350L, 500L & 585L Round tanks
	250L, 300L, 500L & 700L 'D'-Shape tanks
RHS	280L, 350L & 420L Round tanks
	150L & 500L 'D'-Shape tanks

ADBLUE TANKS	DEF TANKS
LHS Outside of Frame	95L & 125L Round tanks and 150L 'D'-Shape tanks
RHS Outside the Frame	60L & 95L Round tanks
WHEELS	10 Stud Options
285mm PCD	8¼" steel disc
	8¼" machine buff disc
	8¼" and 9" polished alloy disc
	8¼" and 9" polished Dura-Bright alloy disc
335mm PCD	8¼" steel disc
	8¼" and 9" polished alloy disc
	8¼" and 9" polished Dura-Bright alloy disc
TYRES	Bridgestone / Michelin tyres
PAINT	Cab/sleeper: Single non-metallic cab colour (Incredible white standard)
	Chassis: Single non-metallic chassis colour (black standard)
ACCESSORIES	Many factory fitted accessories which are not listed are also available
	All customers are encouraged to see their Authorised Dealer for full details

Shaded areas indicate optional specifications.

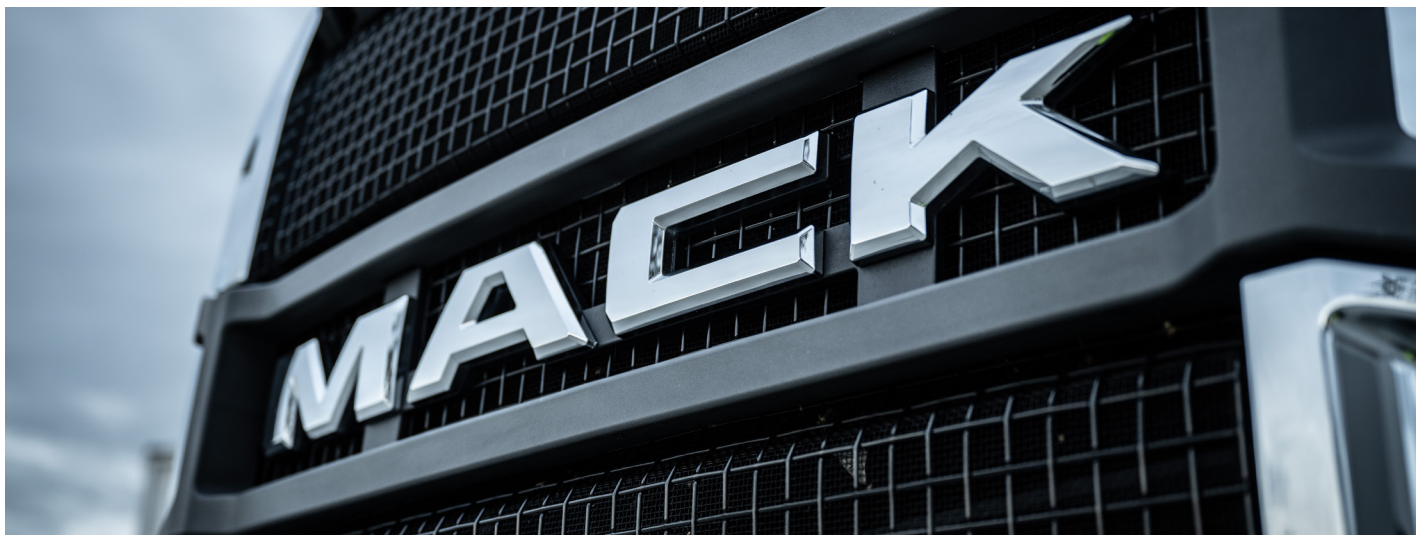

MACK®

All illustrations, specifications and descriptions in this specification are based on the latest product information available at the time of this publication. The right is reserved to make changes in price, materials, equipment, design, specifications, diagrams and models, and to discontinue models of equipment at any time, without notice and without incurring any obligation whatsoever. For more information on additional options and accessories, contact Mack Trucks Australia. (www.macktrucks.com.au).

©2024 Mack Trucks, Inc. All rights reserved. Mack, Mack and the Bulldog design, Bulldog and all other marks contained herein are registered trademarks of Mack Trucks, Inc. and/or Mack Trucks, Inc. affiliated companies. All other marks contained herein are the property of their respective owners.

